

**ozti®**

**-2012-**

**Industrial Kitchen Equipment**



**MADE IN  
TURKEY**

# Öztiryakiler Group Companies

öztiryakiler

ayberg

aymak

özmet

özünoks

ekonomoma

porterra  
forms of porcelain quality

ozti  
Medical & Dental

Gusto  
Gastronomie Geräte GmbH

HOReEQUIP  
SINCE 1986

PERA  
Ankastre Ürünler

özünox

ozti-kz

**Factory / Headoffice**  
Cumhuriyet Mah, Eski Hüdâkâdy Yolu  
No: 37 34900 Beyliközü / İstanbul / Turkey

Expert Direct Tel : (+90,212) 886 78 10 / 11  
Factory Tel : (+90,212) 886 78 00 Pbx  
Expert Direct Fax : (+90,212) 886 62 36  
Factory Fax : (+90,212) 886 64 83  
Expert e-mail : expert@oztiryakiler.com.tr  
Factory e-mail : oztiryakiler@oztiryakiler.com.tr  
www.oztiryakiler.com.tr

**Russia Showroom:**  
109444, Proektiruyemy proezd 5113, D.6  
Moscow - Russia  
Phone: 00 7(495) 797 97 85 /86  
Phone: 007(495) 797 96 78  
Fax: 007(495) 797 96 89  
www.oztinoo.ru  
Info@oztinoo.ru

**Kazakhstan Showroom:**  
050061, Yarmakhammedova st. No.57A  
Almaty- Republic of Kazakhstan  
Phone: 00 7(727) 225 98 12  
Fax: 007(727) 225 26 80  
OSM: 007 (702) 216 04 88  
www.ozti.kz  
Info@ozti.kz

**Gusto Gastronomie Geräte GmbH / Almany Showroom**

**Stuttgart**  
Schelmerwasserstr. 30 / 70567 Stuttgart, Deutschland  
Phone: 0049 711 41135897  
Fax: 0049 711 41135898  
**Berlin**  
Seestr.33 D-13353 Berlin, Deutschland  
Phone: 0049 30 37 44 529 10 - 11  
Fax: 0049 30 37 44 529 20  
www.gusto24.de  
info@gusto24.de

**Horeequip / Romania Showroom**  
Str. Popa Lazar Nr: 5-25 Sector: 2 021586  
Bucharest Zona Bucur Obor - Mecanica Fina  
Tel/Fax: 021 252 91 22-23  
www.horeequip.ro  
office@horeequip.ro



# Experience + Technology



**F**ounded in the 1950's as a family company Oztiyakiler was in its beginning, is today and, will be in the future guided by quality, innovation and confidence. Today we produce more than 4000 different industrial stainless steel kitchen products. Our 85.000 m<sup>2</sup> manufacturing area meets world standards equipped with the latest technology in machinery and our qualified employees.

We are currently exporting to 100 countries. The quality of our products is guaranteed by the various certificates available worldwide. We are approved and maintain the following certification (ISO 9000, ETL, CE, CE-1009, GOST, TUV-GS, NSF, UKRSEPRO)

**B**eing customer oriented we always aim to provide better service to our customers, carrying out total quality management principles, continuous improvements in the design of our products and on going training programs at every department.

Our brand name " Ozti" promises you nothing but the best.

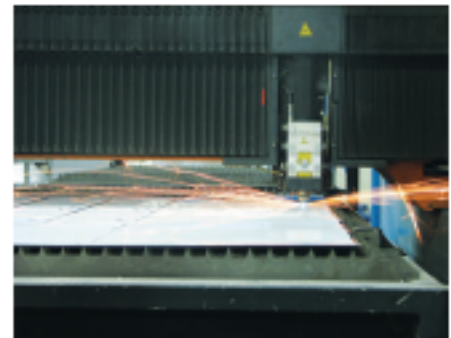

# + Quality = Confidence

**G**egründet in den 50'er Jahren als ein Familienunternehmen; steht der name Öztiryakiler seitdem für **Qualität, Innovation** und **Vertrauen**. Wir fertigen heute mehr als **4.000** verschiedene Grosskücheneinrichtungen. Unsere **85.000 m<sup>2</sup>** Produktionsfläche entspricht weltweit den Standards; sie ist mit den modernsten **Maschinen** und unserem **qualifiziertem Personal** ausgerüstet.

Heute exportieren wir unsere Erzeugnisse nach **100** Ländern. Die **Qualität** unserer Produkte ist durch **weltweit anerkannte Qualitätszertifikate** geprüft und von folgenden Urkunden anerkannt (**ISO 9000, ETL, CE, CE-1009, GOST, TUV-GS, NSF, UKRSEPRO**)

**M**it unserer kundenorientierten **Stellung** ist es unser Ziel; stets **besseren Service** anzubieten, **alle** Prinzipien der **Qualitätssicherung** durchzuführen, den **Design** unserer **Produkte** fortlaufend zu **entwickeln** und in **allen** **Abteilungen** kontinuierliche **Bildungsprogramme** zu machen.

Denn der Name "**Özti**" verspricht Ihnen nur das **Beste**.



# World Standard Industrial Kitchen Equipment

Weltstandard Industrielle

# Küchenausrüstung





# index

## **Cooking Equipment**

*Kochgeschirr*



06-18

## **Carrying Equipment**

*Trageausstattungen*



19-28

## **Gastronorm Containers**

*Gastronormbehälter*



29-36

## **Chafing Dish**

*Chafing Dish*



37-46

## **Trolleys**

*Transportwagen*



47-52

## **Kitchen Utensils**

*Küchenzubehör*



53-72

## **Sink Units**

*Spülbecken*



73-78

## Why we prefer Stainless Steel for Cookware

Stainless Steel has long been the first choice of producers, designers and users of cookware because of the fact that stainless steel products do not stain, chip or rust, are robust and do not affect the flavor of the food, plus their easy cleaning maintenance makes it the first choice for strict hygiene conditions such as found in hospitals, kitchens, abattoirs and other food processing plants.

Stainless steel's bright, easily maintained surface provides a modern look and attractive appearance. What's more, being fully recyclable, stainless steel has good environmental credentials.

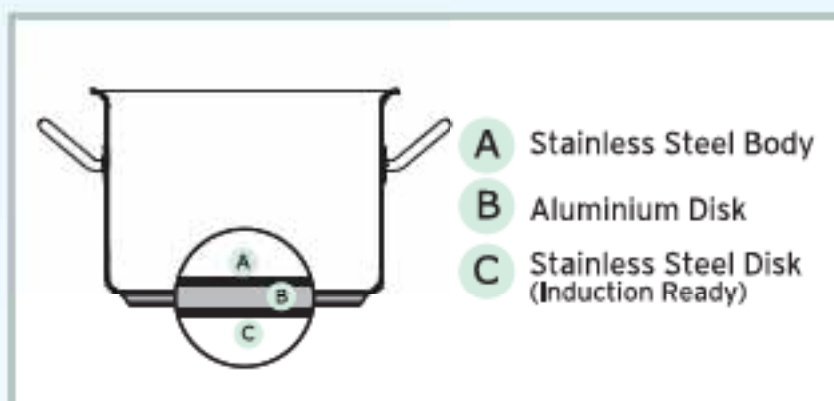

For pots and pans optimum heat transfer is achieved using a triple bottom in stainless steel, aluminium and stainless steel. This heavy duty bottom has a "sandwich" construction with the aluminium enclosed by stainless steel.

With this professional bottom, OZTI pots and pans are perfect for use on any kind of stove whether induction, electrical, glass ceramic or gas.



Stainless steel pots are available in either a smooth satin polished finish or shiny mirror finish or may be semi-satin semi mirror as well.



# Cooking Equipment

*Kochgeschirr*





# Satin Serie

## Seidenmatt Serie

### Induction



**Stock Pot**  
Suppen-Gemüsetopf

Code	Ø (cm)	h (cm)	Capacity (l)	Price (€)
0121.01615.21	16	15	2,75	
0121.02019.21	20	19	5,75	
0121.02219.21	22	19	7	
0121.02420.21	24	20	8,5	
0121.02424.21	24	24	10,5	
0121.02824.21	28	24	14,5	
0121.02828.21	28	28	17	
0121.03232.21	32	32	25	
0121.32275.21	32	27,5	21,5	
0121.03636.21	36	36	36	
0121.04032.21	40	32	37,5	
0121.04040.21	40	40	47,5	
0121.04545.21	45	45	79	
0121.05050.21	50	50	95	
★ 0121.06055.11	60	55	150	

★ Not Suitable for industrial cooking.  
Nicht für Industriekochgeräte geeignet.



**Sauce Pot**  
Fleischtopf

Code	Ø (cm)	h (cm)	Capacity (l)	Price (€)
0121.01611.21	16	11	2	
0121.01812.21	18	12	2,75	
0121.02013.21	20	13	3,75	
0121.22145.21	22	14,5	5,25	
0121.02415.21	24	15	6	
0121.02817.21	28	17	10	
0121.03219.21	32	19	14,5	
0121.03622.21	36	22	20,5	
0121.04025.21	40	25	29,5	
0121.04528.21	45	28	42,5	
0121.05030.21	50	30	54,5	
★ 0121.06035.11	60	35	94	

★ Not Suitable for induction cooking.  
Nicht für Induktionstöpfe geeignet.



**Casserole Pot**  
Bratentopf

Code	Ø (cm)	h (cm)	Capacity (l)	Price (€)
0121.01675.21	16	7,5	1,5	
0121.01808.21	18	8	1,75	
0121.02009.21	20	9	2,5	
0121.24105.21	24	10,5	4,25	
0121.02812.21	28	12	7	
0121.03215.21	32	15	11	
0121.03617.21	36	17	16	
0121.04019.21	40	19	22	
0121.04522.21	45	22	32,5	
0121.05020.21	50	20	35	
★ 0121.06025.11	60	25	63	

★ Not Suitable for induction cooking.  
Nicht für Induktionstöpfe geeignet.

## Satin Serie Seidenmatt Serie



Code	Ø (cm)	h (cm)	Capacity (l)	Price (€)
0143.01611.21	16	11	2	
0143.01812.21	18	12	2,75	
0143.02013.21	20	13	3,75	
0143.22145.21	22	14,5	5,25	
0143.02415.21	24	15	6	
0143.02817.21	28	17	10	

**Sauce Pan**  
Stielkasserole



Code	Ø (cm)	h (cm)	Capacity (l)	Price (€)
0143.01675.21	16	7,5	1,5	
0143.01808.21	18	8	1,75	
0143.02009.21	20	9	2,5	
0143.24105.21	24	10,5	4,25	
0143.02812.21	28	12	7	



**Frypan**  
Bratpfanne



Code	Ø (cm)	h (cm)	Capacity (l)	Price (€)
0144.02004.21	20	4		
0144.02445.21	24	4,5		
0144.02605.21	26	5		
0144.02805.21	28	5		
0144.03255.21	32	5,5		

**Frypan with Additional Handle**  
Bratpfanne mit Gegengriff



Code	Ø (cm)	h (cm)	Capacity (l)	Price (€)
0144.03606.21	36	6		
0144.04006.21	40	6		



**Sauteuse**  
Sauteuse



Code	Ø (cm)	h (cm)	Capacity (l)	Price (€)
0141.01606.21	16	6	0,75	
0141.01806.21	18	6	1	
0141.02006.21	20	6	1,25	
0141.02207.21	22	7	2	
0141.02407.21	24	7	2,25	



**Sauteuse with Rim**  
Sauteuse mit Schüttrand



Code	Ø (cm)	h (cm)	Capacity (l)	Price (€)
0141.01606.22	16	6	0,75	
0141.01806.22	18	6	1	
0141.02006.22	20	6	1,25	
0141.02207.22	22	7	2	
0141.02407.22	24	7	2,25	



## Mirror Serie

### Hochglänzende Serie

#### Induction



**Stock Pot**  
Suppen-Gemüsetopf

Code	B (cm)	h (cm)	Capacity (lt)	Price (€)
0121.01615.41	16	15	2,75	
0121.02019.41	20	19	5,75	
0121.02219.41	22	19	7	
0121.02420.41	24	20	8,5	
0121.02424.41	24	24	10,5	
0121.02824.41	28	24	14,5	
0121.02828.41	28	28	17	
0121.03232.41	32	32	25	
0121.32275.41	32	27,5	21,5	
0121.03636.41	36	36	36	
0121.04032.41	40	32	37,5	
0121.04040.41	40	40	47,5	
0121.04545.41	45	45	79	
0121.05050.41	50	50	95	



**Sauce Pot**  
Fleischtopf

Code	B (cm)	h (cm)	Capacity (lt)	Price (€)
0121.01611.41	16	11	2	
0121.01812.41	18	12	2,75	
0121.02013.41	20	13	3,75	
0121.22145.41	22	14,5	5,25	
0121.02415.41	24	15	6	
0121.02817.41	28	17	10	
0121.03219.41	32	19	14,5	
0121.03622.41	36	22	20,5	
0121.04025.41	40	25	29,5	
0121.04528.41	45	28	42,5	
0121.05030.41	50	30	54,5	



**Casserole Pot**  
Bratentopf

Code	B (cm)	h (cm)	Capacity (lt)	Price (€)
0121.01675.41	16	7,5	1,5	
0121.01808.41	18	8	1,75	
0121.02009.41	20	9	2,5	
0121.24105.41	24	10,5	4,25	
0121.02812.41	28	12	7	
0121.03215.41	32	15	11	
0121.03617.41	36	17	16	
0121.04019.41	40	19	22	
0121.04522.41	45	22	32,5	
0121.05020.41	50	20	35	

## Mirror Serie Hochglänzende Serie



Code	Ø (cm)	h (cm)	Capacity (l)	Price (€)
0143.01611.41	16	11	2	
0143.01812.41	18	12	2.75	
0143.02013.41	20	13	3.75	
0143.22145.41	22	14.5	5.25	
0143.02415.41	24	15	6	
0143.02817.41	28	17	10	

**Sauce Pan**  
Stielkasserole



Code	Ø (cm)	h (cm)	Capacity (l)	Price (€)
0143.01675.41	16	7.5	1.5	
0143.01808.41	18	8	1.75	
0143.02009.41	20	9	2.5	
0143.24105.41	24	10.5	4.25	
0143.02812.41	28	12	7	



**Frypan**  
Bratpfanne



Code	Ø (cm)	h (cm)	Capacity (l)	Price (€)
0144.02004.41	20	4		
0144.02445.41	24	4.5		
0144.02605.41	26	5		
0144.02805.41	28	5		
0144.03255.41	32	5.5		

**Frypan with Additional Handle**  
Bratpfanne mit Gegenriff



Code	Ø (cm)	h (cm)	Capacity (l)	Price (€)
0144.03606.41	36	6		
0144.04006.41	40	6		

With Add. Handle



**Sauteuse**  
Sauteuse



Code	Ø (cm)	h (cm)	Capacity (l)	Price (€)
0141.01606.41	16	6	0.75	
0141.01806.41	18	6	1	
0141.02006.41	20	6	1.25	
0141.02207.41	22	7	2	
0141.02407.41	24	7	2.25	



**Sauteuse with Rim**  
Sauteuse mit Schüttrand



Code	Ø (cm)	h (cm)	Capacity (l)	Price (€)
0141.01606.42	16	6	0.75	
0141.01806.42	18	6	1	
0141.02006.42	20	6	1.25	
0141.02207.42	22	7	2	
0141.02407.42	24	7	2.25	

## Semi Satin-Semi Mirror Serie Semi Ausführung

### Induction



**Stock Pot**  
Suppen-Gemüsetopf

Code	Ø (cm)	h (cm)	Capacity (l)	Price (€)
0121.01615.61	16	15	2,75	
0121.02019.61	20	19	5,75	
0121.02219.61	22	19	7	
0121.02420.61	24	20	8,5	
0121.02424.61	24	24	10,5	
0121.02824.61	28	24	14,5	
0121.02828.61	28	28	17	
0121.03232.61	32	32	25	
0121.32275.61	32	27,5	21,5	
0121.03636.61	36	36	36	
0121.04032.61	40	32	37,5	
0121.04040.61	40	40	47,5	



**Sauce Pot**  
Fleischtopf

Code	Ø (cm)	h (cm)	Capacity (l)	Price (€)
0121.01611.61	16	11	2	
0121.01812.61	18	12	2,75	
0121.02013.61	20	13	3,75	
0121.22145.61	22	14,5	5,25	
0121.02415.61	24	15	6	
0121.02817.61	28	17	10	
0121.03219.61	32	19	14,5	
0121.03622.61	36	22	20,5	
0121.04025.61	40	25	29,5	



**Casserole Pot**  
Bratentopf

Code	Ø (cm)	h (cm)	Capacity (l)	Price (€)
0121.01675.61	16	7,5	1,5	
0121.01808.61	18	8	1,75	
0121.02009.61	20	9	2,5	
0121.24105.61	24	10,5	4,25	
0121.02812.61	28	12	7	
0121.03215.61	32	15	11	
0121.03617.61	36	17	16	
0121.04019.61	40	19	22	



**Sauce Pan**  
Stielkasserole

Code	Ø (cm)	h (cm)	Capacity (l)	Price (€)
0143.01611.61	16	11	2	
0143.01812.61	18	12	2,75	
0143.02013.61	20	13	3,75	
0143.22145.61	22	14,5	5,25	
0143.02415.61	24	15	6	
0143.02817.61	28	17	10	

Code	Ø (cm)	h (cm)	Capacity (l)	Price (€)
0143.01675.61	16	7,5	1,5	
0143.01808.61	18	8	1,75	
0143.02009.61	20	9	2,5	
0143.24105.61	24	10,5	4,25	
0143.02812.61	28	12	7	

# Lid Deckel



## Dome Lid Satin Deckel (Seidenmatt)



Code	Ø (cm)	Price (€)
0122.00012.11	12	
0122.00014.11	14	
0122.00016.11	16	
0122.00018.11	18	
0122.00020.11	20	
0122.00022.11	22	
0122.00024.11	24	
0122.00026.11	26	
0122.00028.11	28	
0122.00032.11	32	
0122.00036.11	36	
0122.00040.11	40	
0122.00045.11	45	
0122.00050.11	50	

## Dome Lid Mirror Deckel (Hochglänzend)



Code	Ø (cm)	Price (€)
0122.00012.21	12	
0122.00014.21	14	
0122.00016.21	16	
0122.00018.21	18	
0122.00020.21	20	
0122.00022.21	22	
0122.00024.21	24	
0122.00026.21	26	
0122.00028.21	28	
0122.00032.21	32	
0122.00036.21	36	
0122.00040.21	40	
0122.00045.21	45	
0122.00050.21	50	

## Flat Lid Satin Deckel (Seidenmatt)



Code	Ø (cm)	Price (€)
0122.00014.12	14	
0122.00016.12	16	
0122.00018.12	18	
0122.00020.12	20	
0122.00022.12	22	
0122.00024.12	24	
0122.00026.12	26	
0122.00028.12	28	
0122.00032.12	32	
0122.00036.12	36	
0122.00040.12	40	
0122.00045.12	45	
0122.00050.12	50	
0122.00060.12	60	

## Flat Lid Mirror Deckel (Hochglänzend)



Code	Ø (cm)	Price (€)
0122.00014.22	14	
0122.00016.22	16	
0122.00018.22	18	
0122.00020.22	20	
0122.00022.22	22	
0122.00024.22	24	
0122.00026.22	26	
0122.00028.22	28	
0122.00032.22	32	
0122.00036.22	36	
0122.00040.22	40	
0122.00045.22	45	
0122.00050.22	50	

## Belly Lid Satin Deckel (Seidenmatt)



Code	Ø (cm)	Price (€)
0122.00016.13	16	
0122.00018.13	18	
0122.00020.13	20	
0122.00024.13	24	
0122.00028.13	28	
0122.00032.13	32	
0122.00036.13	36	
0122.00040.13	40	

## Belly Lid Mirror Deckel (Hochglänzend)



Code	Ø (cm)	Price (€)
0122.00016.25	16	
0122.00018.25	18	
0122.00020.25	20	
0122.00024.25	24	
0122.00028.25	28	
0122.00032.25	32	
0122.00036.25	36	
0122.00040.25	40	

# Frypan Bratpfanne

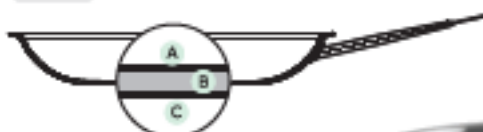

- A Stainless Steel
- B Aluminium
- C Stainless Steel

## Frypan Multilayer Bratpfanne



Code	Ø (cm)	h (cm)	Price (€)
0147.02035.71	20	3.5	
0147.02440.71	24	4	
0147.02645.71	26	4.5	
0147.02845.71	28	4.5	
0147.03250.71	32	5	

Code	Ø (cm)	h (cm)	Price (€)
0147.03655.71	36	5.5	
0147.04055.71	40	5.5	

With Add. Handle / Mit Gegengriff

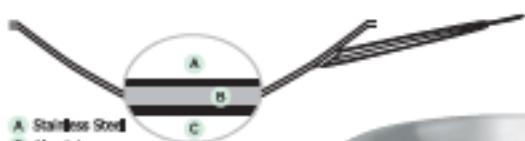

- A Stainless Steel
- B Aluminium
- C Stainless Steel

## Wok Multilayer Wok



Code	Ø (cm)	h (cm)	Price (€)
0147.03808.71	38	8	



Code	Ø (cm)	h (cm)	Price (€)
0149.02004.41	20	4	
0149.02445.41	24	4.5	
0149.02605.41	26	5	
0149.02805.41	28	5	
0149.03255.41	32	5.5	



## Non-Stick Coated Frypan Antihaftbeschichtete Bratpfannen



Code	Ø (cm)	h (cm)	Price (€)
0149.03606.41	36	6	
0149.04006.41	40	6	

With Add. Handle / Mit Gegengriff

## Paella Pan Satin Finished (Frypan with two handles) Paella-Pfanne, Seidenmatt



Code	Ø (cm)	h (cm)	Price (€)
0144.02004.22	20	4	
0144.02445.22	24	4.5	
0144.02605.22	26	5	
0144.02805.22	28	5	
0144.03255.22	32	5.5	
0144.03606.22	36	6	
0144.04006.22	40	6	



## Paella Pan Mirror Finished (Frypan with two handles) Paella-Pfanne, Hochgläzend



Code	Ø (cm)	h (cm)	Price (€)
0144.02004.42	20	4	
0144.02445.42	24	4.5	
0144.02605.42	26	5	
0144.02805.42	28	5	
0144.03255.42	32	5.5	
0144.03606.42	36	6	
0144.04006.42	40	6	



### New Couscous Set



**Couscous Cooker**  
Kuskustopf



Code	Set	Ø (cm)	h (cm)	Capacity (l)	Price (€)
0134.02812.01					
	Strainer 28x12	28	12		
	(with lid) Stock pot 28x17	28	17	10	
0134.03215.01					
	Strainer 32x15	32	15		
	(with lid) Stock pot 32x19	32	19	14.5	
0134.03617.01					
	Strainer 36x17	36	17		
	(with lid) Stock pot 36x22	36	22	20.5	

Also bigger sizes are available



**Special Steamcooking Set**  
with one Pot and two Strainer  
Dampfkocheck mit  
einem Topf und zwei Sieber

**Double Boiler**  
Topf (3 Teilig)



Code	Set	Ø (cm)	h (cm)	Capacity (l)	Price (€)
0134.00028.01					
2 x	Strainer 28x12	28	12		
	Stockpot 28x17	28	17	10	
0134.00032.01					
2 x	Strainer 32x15	32	15		
	Stockpot 32x19	32	19	14.5	
0134.00036.01					
2 x	Strainer 36x17	36	17		
	Stockpot 36x22	36	22	20.5	



**Fish Kettle s/s**  
Fischkochkessel  
Edelstahl Rostfrei

Code	Dimensions (cm)	h (cm)	Price (€)
0323.00050.01	50x16	12	





**S/S Pressure Cooker**  
Edelstahl Dampfkochtopf

Code	Ø (cm)	h (cm)	Price (€)
8160.03230.00	32	30	
8160.03223.00	32	23	
8160.03219.00	32	19	



**Wide Shallow Pots with Lid**  
Kochtöpfe mit Deckel

Code	Ø (cm)	h (cm)	Capacity (l)	Price (€)
0110.03015.02	30	15	9,5	
0110.03615.02	36	15	14	
0110.03620.02	36	20	19	
0110.04017.02	40	17	19	
0110.04520.02	45	20	31	
0110.05020.02	50	20	36	
0110.05520.02	55	20	40	
0110.06020.02	60	20	45	
0110.06525.02	65	25	76	
0110.07030.02	70	30	108	
0110.08030.02	80	30	136	
0110.09030.04	90	30	166	
0110.10035.04	100	35	258	
0110.11035.04	110	35	289	



**Pan with Handle**  
Bratpfanne mit Seitengriffen

Code	Ø (cm)	h (cm)	Price (€)
0145.04011.01	40	11	
0145.05012.01	50	12	
0145.06014.01	60	14	
0145.07015.01	70	15	
0145.08016.01	80	16	
0145.10018.01	100	18	



**Shallow Strainer**  
Seiher, niedrig

Code	Ø (cm)	h (cm)	Price (€)
0337.04011.01	40	11	
0337.05012.01	50	12	
0337.06014.01	60	14	
0337.07015.01	70	15	
0337.08016.01	80	16	
0337.10018.01	100	18	



# Aluminium Frypan Non-Stick Coated

## Aluminium Bratpfanne mit Antihafbeschichtung

**Cast Aluminium Show Pan Non-Stick Coated**  
Aluguss-Riesenpfanne mit Antihafbeschichtung und Mittelsteg

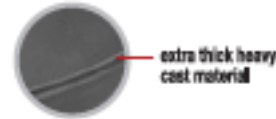

Code	Ø (cm)	h (cm)	Price (€)
8149.00050.00	46	7	
8149.00060.00	60	10	

**Cast Aluminium Show Pan Non-Stick Coated (2 Division)**  
Aluguss-Riesenpfanne mit Antihafbeschichtung und Mittelsteg

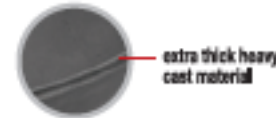

Code	Ø (cm)	h (cm)	Price (€)
8149.00060.01	60	10	

**Aluminium Frypan Non-Stick Coated**  
Aluminium Bratpfanne mit Antihafbeschichtung



Code	Ø (cm)	h (cm)	Thickness (mm)	Price (€)
9149.00140.20	20	4	4	
9149.00140.24	24	4	4	
9149.00140.26	26	4.2	4	
9149.00140.28	28	4	4	
9149.00140.30	30	4.8	4	
9149.00140.32	32	5	5	
9149.00140.36	36	5.5	5	
9149.00140.40	40	6	5	

**Aluminium Crepe Pan Non-Stick Coated**  
Aluminium Crepes-Pfanne mit Antihafbeschichtung



Code	Ø (cm)	h (cm)	Thickness (mm)	Price (€)
9149.00138.14	14	2	2.5	
8149.00138.16	16	2.5	2.8	
8149.00138.18	18	2.7	2.8	
8149.00138.20	20	2.7	3.2	
9149.00138.22	22	2.8	3.2	
8149.00138.24	24	2.8	3.5	
9149.00138.26	26	2	3	
9149.00138.28	28	3	3.5	
8149.00138.30	30	3	3.5	
8149.00138.32	32	3	3.5	

**Aluminium Wok Pan Non-Stick Coated**  
Aluminium Wok-Pfanne mit Antihafbeschichtung



Code	Ø (cm)	h (cm)	Thickness (mm)	Price (€)
8149.00141.24	24	7.6	3	
8149.00141.26	26	8	3.5	
9149.00141.28	28	9	3.5	
9149.00141.30	30	9	4	
8149.00141.32	32	10	4	



**Asparagus Pot**  
Spargeltopf

Code	Ø (cm)	h (cm)	Capacity (lt)	Price (€)
0120.01420.61	14	20	3	
0120.01629.61	16	29	6	

with lid and strainer / mit Deckel und Einsatz



Code	Ø (cm)	h (cm)	Price (€)
0339.02009.11	20	9	



Code	Ø (cm)	h (cm)	Price (€)
0339.02015.11	20	15	

The steam pots best fit with stock pots semi satin-semi mirror 20x13 and 20x17.

Die Dampfkochaufsätze sind am besten für die 20x13 und 20x17 Semi-Ausführung Töpfe geeignet.



Pots	Steam Pot	Ø (cm)	h (cm)	Capacity (lt)	Price (€)
0121.02013.63	for 0339.02009.11	20	13	3.75	
0121.02017.63	for 0339.02015.11	20	17	5.25	

**Steam Pot**  
Dampfkochaufsatz

Lid	Ø (cm)	Price (€)
0122.00020.22	20	



Code		Ø (cm)	h (cm)	Price (€)
0339.03623.01	4 pcs	36	23	
0339.04026.01	4 pcs	40	26	



Code		Ø (cm)	h (cm)	Price (€)
0339.03623.11	1 pcs	36	23	
0339.04026.11	1 pcs	40	26	

The pasta cookers best fit with stock pots mirror 36x22 and 40x25. Nudleinsätze sind am besten für die 36x22 und 40x25 Hochglänzende Töpfe geeignet.

Pots		Ø (cm)	h (cm)	Capacity (lt)	Price (€)
0121.03622.41	for 0339.03623.11	36	22	20.5	
0121.04025.41	for 0339.04026.11	40	25	29.5	

**Pasta Cooker**  
Nudleinsatz

Lid	Ø (cm)	Price (€)
0122.00036.21	36	
0122.00040.21	40	



# Carrying Equipment

*Trageausstattungen*





## Roasting Pan

### Rechteckige Bratpfannen



**Roasting Pan**  
Rechteckige Bratpfannen

Code	Dimension (cm)	h (cm)	Capacity (l)	Price (€)
0211.35405.13	35x40	5	6.5	
0211.35408.12	35x40	8	10.5	
0211.40505.13	40x50	5	9.5	
0211.40508.12	40x50	8	15.5	
0211.45605.13	45x60	5	13	
0211.45608.12	45x60	8	21	
0211.45601.12	45x60	10	26	
0211.50705.13	50x70	5	17	
0211.50708.12	50x70	8	27	
0211.50701.12	50x70	10	34	

**4 and 5 cm height trays are without handle**  
4 und 5 cm tiefe Pfannen sind ohne Griffe

**Whitford**



**Non-Stick Roasting Pan**  
Rechteckige Bratpfannen,  
beschichtet

Code	Dimension (cm)	h (cm)	Capacity (l)	Price (€)
0214.35405.13	35x40	5	6.5	
0214.35408.12	35x40	8	10.5	
0214.40505.13	40x50	5	9.5	
0214.40508.12	40x50	8	15.5	
0214.45605.13	45x60	5	13	
0214.45608.12	45x60	8	21	
0214.45601.12	45x60	10	26	
0214.50705.13	50x70	5	17	
0214.50708.12	50x70	8	27	
0214.50701.12	50x70	10	34	

**5 cm height trays are without handle**  
5 cm tiefe Pfannen sind ohne Griffe



**Roasting Pan Lid**  
Rechteckiger  
Bratpfannendeckel

Code	Dimension (cm)	Price (€)
0212.03540.12	35x40	
0212.05040.12	40x50	
0212.06045.12	45x60	
0212.05070.12	50x70	



**Food Carrying Containers With Faucet**  
Transport-Kochtöpfe mit Zapfhahn



Code	B (cm)	h (cm)	Capacity (l)	Price (€)
0220.03636.11	36	36	36	
0220.04040.11	40	40	47.5	

without sandwich bottom  
Ohne Unterboden

Code	B (cm)	h (cm)	Capacity (l)	Price (€)
0220.03636.21	36	36	36	
0220.04040.21	40	40	47.5	

with sandwich bottom induction ready  
mit Unterboden, Induktionsfähig

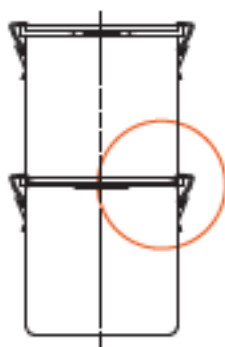

Code	B (cm)	h (cm)	Capacity (l)	Price (€)
0220.02415.10	24	15	6	
0220.02424.10	24	24	10.5	
0220.02824.10	28	24	14.5	
0220.02828.10	28	28	17	
0220.03022.10	30	22	15	
0220.03028.10	30	28	20	
0220.03032.10	30	32	22	
0220.03636.10	36	36	36	
0220.04040.10	40	40	47.5	
0220.04545.10	45	45	79	
0220.05050.10	50	50	95	

without sandwich bottom  
Ohne Unterboden



Code	B (cm)	h (cm)	Capacity (l)	Price (€)
0220.02415.20	24	15	6	
0220.02424.20	24	24	10.5	
0220.02824.20	28	24	14.5	
0220.02828.20	28	28	17	
0220.03022.20	30	22	15	
0220.03028.20	30	28	20	
0220.03032.20	30	32	22	
0220.03636.20	36	36	36	
0220.04040.20	40	40	47.5	
0220.04545.20	45	45	79	
0220.05050.20	50	50	95	

with sandwich bottom induction ready  
mit Unterboden, Induktionsfähig

**Food Carrying Containers**  
Transport-Kochtöpfe



**Food Carrying Containers  
Double Skin**  
Transport-Kochtöpfe  
mit Doppelwand

Code	B (cm)	h (cm)	Capacity (l)	Price (€)
0270.03217.01	32	17	10	
0270.03223.01	32	23	15	
0270.03231.01	32	31	20	



**Food Carrying Containers  
Double Skin,  
with rubber protection**  
Transport-Kochtöpfe  
mit Doppelwand und  
Gummidichtung



Code	B (cm)	h (cm)	Capacity (l)	Price (€)
0270.03217.11	32	17	10	
0270.03223.11	32	23	15	
0270.03231.11	32	31	20	



**Food Carrying Containers  
Double Skin, with faucet**  
Transport-Kochtöpfe  
mit Doppelwand und Zapfhahn

Code	B (cm)	h (cm)	Capacity (l)	Price (€)
0270.03217.75	32	17	10	
0270.03223.75	32	23	15	
0270.03231.75	32	31	20	

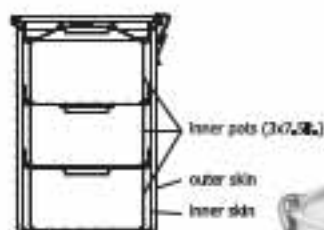

with three innerpots (25x15)  
mit 3 Innenköpfe (25x15)

Code	B (cm)	h (cm)	Capacity (l)	Price (€)
0270.03247.01	32	47	3x7,5	
★ 0270.03247.11	32	47	3x7,5	

★ with rubber protection  
mit Gummidichtung

**Food Carrying Containers Double Skin**  
Transport-Kochtöpfe mit Doppelwand

Without inner pots  
ohne Innenköpfe

Code	B (cm)	h (cm)	Capacity (l)	Price (€)
0270.03247.02	32	47	30	
★ 0270.03247.12	32	47	30	

★ with rubber protection  
mit Gummidichtung

**FOOD CARRYING CONTAINERS DOUBLE SKIN WITHOUT SILICONE RUBBER**

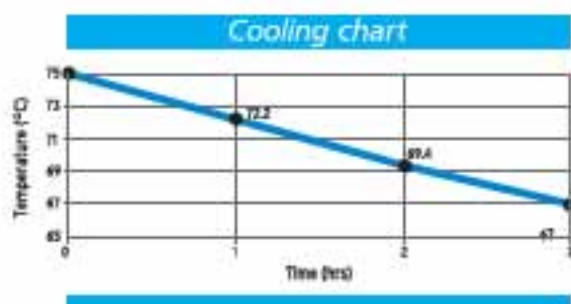

Temperature loss at hot meals

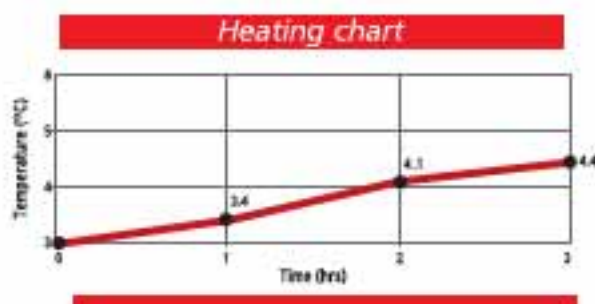

Temperature loss at cold meals





# Thermotrans



OT300

The Thermotrans are ideal units for the transportation of hot and cold foods with their special construction of polypropylene external body and polyurethane isolation material ( FCKW free ).

Gastronorm Containers between 2,5 and 28 liter capacity can be placed into the Thermotrans and the proper usage of Gastronorms Containers with silicon lid prevents spilling of the foods.

The Thermotrans are stackable and dishwasher safe. Heat & Cold resistant for +100 und -40 ° C.

Thermotrans ist eine spezialkonstruktion. Die Außenschicht besteht aus Polypropylen und Innen ist sie durch Polyurethan isoliert. Thermotrans eignet sich somit ideal für den Transport von kalten und warmen Speisen.

Gastro-Behälter mit einer Kapazität vor 2,5 und 28 Liter können in den Thermotrans Platz finden. Thermotrans verhindert in Kombination mit silikonbeschichteten Gastro-Behälter das Überlaufen der Speisen.

Die Thermotrans sind stapelbar und Spülmaschinenfest Heiß und Kalt resistent bei Temparetuen von +100 bis -40°C.



OT600



# Thermotrans



## Thermotrans OT 100



Code	Color	LxWxH (cm)	Price (€)
8224.0T100.01	Green	42x62x30.5	
8224.0T100.02	Blue	42x62x30.5	

## Thermotrans OT 300



Code	Color	LxWxH (cm)	Price (€)
8224.0T300.01	Green	42x62x40.5	
8224.0T300.02	Blue	42x62x40.5	

## Thermotrans OT 400

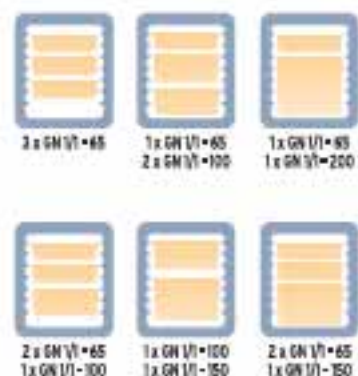

Code	Color	LxWxH (cm)	Price (€)
8224.0T400.01	Green	47.5x67x44.5	
8224.0T400.02	Blue	47.5x67x44.5	



# Thermotrans

## Thermotrans OT 600

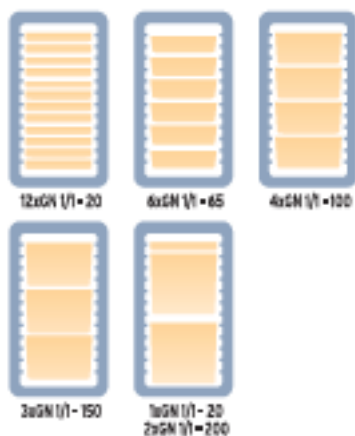

Code	Color	LxWxH (cm)	Price (€)
* 8224.OT600.M1	Green	44x68x63	
* 8224.OT600.M2	Blue	44x68x63	

Code	Color	LxWxH (cm)	Price (€)
8224.OT600.01	Green	44x68x63	
8224.OT600.02	Blue	44x68x63	

\* With Hinged Door



## Thermotrans OT 1200 for 2/1 GN containers

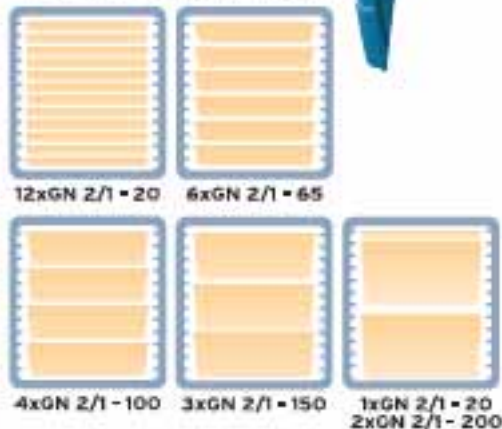

Code	Color	LxWxH (cm)	Price (€)
8224.OT120.02	Blue	67x76,5x62	

## THERMOTRANS

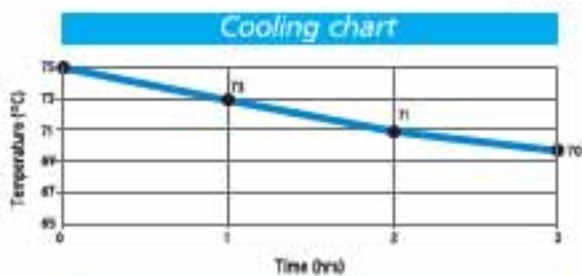

Temperature loss at hot meals



Temperature loss at cold meals



# Thermotray



## Thermotray with Cover

Porcelain Plates for Thermotray • 6 division

- 23 cm flat plate or 20 cm deep plate
- 17 cm oval plate or 12 cm bowl
- 17 cm oval plate or 12 cm bowl
- 14 cm oval plate
- 12 cm bowl
- Tea cup

(Porcelain plates are not included)



Code	Dimensions (cm)	Capacity (lit)	Price (€)
8220.0T100.00	38x53x10		
<b>6 Division</b>			

## Thermotray with Cover

Porcelain Plates for Thermotray • 5 division

- 23 cm flat plate or 12 cm bowl
- 20 cm deep plate or 12 cm bowl
- 17 cm oval plate or 12 cm bowl
- 14 cm oval plate or tea pot
- 12 cm bowl

(Porcelain plates are not included)



Code	Dimensions (cm)	Capacity (lit)	Price (€)
8220.0T100.05	37x52x12		
<b>5 Division</b>			

## Thermotray with Half Cover

Porcelain Plates for Thermotray (Half cover) - 5 division

- 23 cm flat plate or 12 cm bowl
- 20 cm deep plate or 12 cm bowl
- 17 cm oval plate or 12 cm bowl
- 14 cm oval plate or tea pot
- 12 cm bowl

(Porcelain plates are not included)



Code	Dimensions (cm)	Capacity (lit)	Price (€)
8220.00T50.00	38x53x12		
<b>5 Division</b>			



## Dishwasher Baskets Spülmaschinenkörbe



**Base Rack  
with Compartment**  
Grundkorb für Gläser

Code	Dimensions (cm)	Price (€)
8740.0BB09.00	with 9 Compartment 50x50x10	
8740.0BB16.00	with 16 Compartment 50x50x10	
8740.0BB25.00	with 25 Compartment 50x50x10	
8740.0BB36.00	with 36 Compartment 50x50x10	
8740.0BB49.00	with 49 Compartment 50x50x10	

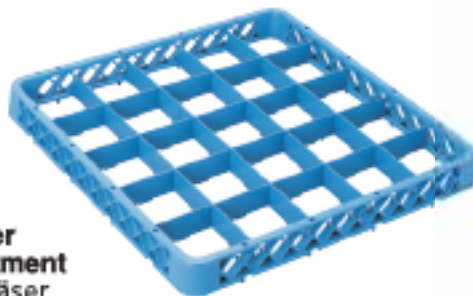

**Rack Extender  
with Compartment**  
Aufsatz für Gläser

Code	Dimensions (cm)	Price (€)
8740.0BY09.00	with 9 Compartment 50x50x4.5	
8740.0BY16.00	with 16 Compartment 50x50x4.5	
8740.0BY25.00	with 25 Compartment 50x50x4.5	
8740.0BY36.00	with 36 Compartment 50x50x4.5	
8740.0BY49.00	with 49 Compartment 50x50x4.5	



**Rack Base for  
Plate and Tray**  
Teller- und Tablettkorb

Code	Dimensions (cm)	Price (€)
8740.0TB50.00	50x50x10	



**Rack Base  
for Cutlery**  
Besteckkorb

Code	Dimensions (cm)	Price (€)
8740.0CK50.00	50x50x10	



**Open Rack**  
Universalkorb

Code	Dimensions (mm)	Price (€)
8740.0DB50.00	500x500x100	



# Gastronorm Containers

*Gastronormbehälter*





## Gastronorm Containers Gastronormbehälter

**GN 1/1**  
530x325 mm



0311.11020.10	20	1,9
0311.11040.10	40	4,5
0311.11055.10	55	6,2
0311.11065.10	65	7,4
0311.11100.10	100	12,6
0311.11150.10	150	18
0311.11200.10	200	25

**GN 2/3**  
354x325 mm



0311.23020.10	20	1,25
0311.23040.10	40	3
0311.23065.10	65	5,25
0311.23100.10	100	8
0311.23150.10	150	11,5
0311.23200.10	200	16,25

**GN 1/2**  
325x265 mm



0311.12020.10	20	0,85
0311.12040.10	40	1,75
0311.12055.10	55	2,5
0311.12065.10	65	3,5
0311.12100.10	100	5,5
0311.12150.10	150	8,5
0311.12200.10	200	11

**GN 1/3**  
325x176 mm



0311.13020.10	20	0,6
0311.13040.10	40	1,5
0311.13065.10	65	2,25
0311.13100.10	100	3,5
0311.13150.10	150	5,5
0311.13200.10	200	7,25

**GN 1/4**  
265x162 mm



0311.14020.10	20	0,4
0311.14040.10	40	1
0311.14065.10	65	1,5
0311.14100.10	100	2,5
0311.14150.10	150	3,75
0311.14200.10	200	5,25

**GN 1/6**  
176x162 mm



0311.16065.10	65	1
0311.16100.10	100	1,5
0311.16150.10	150	2,25
0311.16200.10	200	3

**GN 1/9**  
176x108 mm



0311.19065.10	65	0,5
0311.19100.10	100	0,8

**GN 2/1**  
650x530 mm



Code	h (mm)	Capacity (l)	Price(€)
0311.21020.10	20	4,5	
0311.21040.10	40	10	
0311.21065.10	65	16,5	
0311.21100.10	100	26	
0311.21150.10	150	40	
0311.21200.10	200	55	

**GN 2/4**  
530x162 mm



0311.24020.10	20	0,85
0311.24040.10	40	1,75
0311.24065.10	65	3,5
0311.24100.10	100	5,5
0311.24150.10	150	8,5



## Gastronorm Containers with Handle Gastronormbehälter mit Fallgriffen

**GH 1/1**  
530x325 mm



Code	h (mm)	Capacity (l)	Price(€)
0311.1065.11	65	7.4	
0311.1100.11	100	12.6	
0311.1150.11	150	18	
0311.1200.11	200	25	

**GH 2/3**  
354x325 mm



Code	h (mm)	Capacity (l)	Price(€)
0311.23065.11	65	5.25	
0311.23100.11	100	8	
0311.23150.11	150	11.5	
0311.23200.11	200	16.25	

**GH 1/2**  
325x265 mm



Code	h (mm)	Capacity (l)	Price(€)
0311.12065.11	65	3.5	
0311.12100.11	100	5.5	
0311.12150.11	150	8.5	
0311.12200.11	200	11	

**GH 1/3**  
325x176 mm



Code	h (mm)	Capacity (l)	Price(€)
0311.13065.11	65	2.25	
0311.13100.11	100	3.5	
0311.13150.11	150	5.5	
0311.13200.11	200	7.25	

**GH 1/4**  
265x162 mm



Code	h (mm)	Capacity (l)	Price(€)
0311.14065.11	65	1.5	
0311.14100.11	100	2.5	
0311.14150.11	150	3.75	
0311.14200.11	200	5.25	

**GH 1/6**  
176x162 mm



Code	h (mm)	Capacity (l)	Price(€)
0311.16065.11	65	1	
0311.16100.11	100	1.5	
0311.16150.11	150	2.25	
0311.16200.11	200	3	

**GH 2/1**  
650x530 mm



Code	h (mm)	Capacity (l)	Price(€)
0311.21065.11	65	16.5	
0311.21100.11	100	26	
0311.21150.11	150	40	
0311.21200.11	200	55	

**GH 2/4**  
530x162 mm



Code	h (mm)	Capacity (l)	Price(€)
0311.24065.11	65	3.5	
0311.24100.11	100	5.5	
0311.24150.11	150	8.5	





## Perforated Gastronorm Containers Perforierte Gastronormbehälter

**GNP 1/1**  
530x325 mm



Code	h (mm)	Capacity (l)	Price(€)
0311.11020.21	20		
0311.11040.21	40		
0311.11055.21	55		
0311.11065.21	65		
0311.11100.21	100		
0311.11150.21	150		
0311.11200.21	200		

**GNP 2/3**  
354x325 mm



Code	h (mm)	Capacity (l)	Price(€)
0311.23020.21	20		
0311.23040.21	40		
0311.23065.21	65		
0311.23100.21	100		
0311.23150.21	150		
0311.23200.21	200		

**GNP 1/2**  
325x265 mm



Code	h (mm)	Capacity (l)	Price(€)
0311.12020.21	20		
0311.12040.21	40		
0311.12055.21	55		
0311.12065.21	65		
0311.12100.21	100		
0311.12150.21	150		
0311.12200.21	200		

**GNP 1/3**  
325x176 mm



Code	h (mm)	Capacity (l)	Price(€)
0311.13020.21	20		
0311.13040.21	40		
0311.13065.21	65		
0311.13100.21	100		
0311.13150.21	150		
0311.13200.21	200		

**GNP 1/4**  
265x162 mm



Code	h (mm)	Capacity (l)	Price(€)
0311.14020.21	20		
0311.14040.21	40		
0311.14065.21	65		
0311.14100.21	100		
0311.14150.21	150		
0311.14200.21	200		

**GNP 1/6**  
176x162 mm



Code	h (mm)	Capacity (l)	Price(€)
0311.16065.21	65		
0311.16100.21	100		
0311.16150.21	150		

**GNP 2/1**  
650x530 mm



Code	h (mm)	Capacity (l)	Price(€)
0311.21020.21	20		
0311.21040.21	40		
0311.21065.21	65		
0311.21100.21	100		
0311.21150.21	150		
0311.21200.21	200		

**GNP 2/4**  
530x162 mm



Code	h (mm)	Capacity (l)	Price(€)
0311.24020.21	20		
0311.24040.21	40		
0311.24065.21	65		
0311.24100.21	100		
0311.24150.21	150		

## Gastronorm Lids Gastronorm Deckel



**Standard GN Lid  
GN-Deckel**



Code		Dimensions (mm)	Price (€)
0312.00021.10	GD 2/1	650x530	
0312.00011.10	GD 1/1	530x325	
0312.00023.10	GD 2/3	354x325	
0312.00012.10	GD 1/2	325x265	
0312.00013.10	GD 1/3	325x176	
0312.00014.10	GD 1/4	265x162	
0312.00016.10	GD 1/6	176x162	
0312.00019.10	GD 1/9	176x108	
0312.00024.10	GD 2/4	530x162	

**Ladle Cutout GN Lid  
GN-Deckel mit Löffelaussparung**



Code		Dimensions (mm)	Price (€)
0312.00021.11	GDD 2/1	650x530	
0312.00011.11	GDD 1/1	530x325	
0312.00023.11	GDD 2/3	354x325	
0312.00012.11	GDD 1/2	325x265	
0312.00013.11	GDD 1/3	325x176	
0312.00014.11	GDD 1/4	265x162	
0312.00016.11	GDD 1/6	176x162	
0312.00019.11	GDD 1/9	176x108	
0312.00024.11	GDD 2/4	530x162	

**GN Lid with Silicon  
GN-Deckel mit Silikondichtung**



Code		Dimensions (mm)	Price (€)
0312.00011.21	GDC 1/1	505x300	
0312.00023.21	GDC 2/3	329x300	
0312.00012.21	GDC 1/2	300x252	
0312.00013.21	GDC 1/3	300x151	
0312.00014.21	GDC 1/4	240x137	
0312.00016.21	GDC 1/6	151x137	
0312.00024.21	GDC 2/4	505x137	

**Lid for GN Container with  
Handle and Ladle Cut  
GN-Deckel mit Aussparung  
für Griff und Löffel**



Code		Dimensions (mm)	Price (€)
0312.00021.12	GDDH 2/1	650x530	
0312.00011.12	GDDH 1/1	530x325	
0312.00023.12	GDDH 2/3	354x325	
0312.00012.12	GDDH 1/2	325x265	
0312.00013.12	GDDH 1/3	325x176	
0312.00014.12	GDDH 1/4	265x162	
0312.00016.12	GDDH 1/6	176x162	
0312.00024.12	GDDH 2/4	530x162	

**Lid for GN Container  
with Handle  
Deckel für GN mit Fallgriffen**



Code		Dimensions (mm)	Price (€)
0312.00021.13	GDH 2/1	650x530	
0312.00011.13	GDH 1/1	530x325	
0312.00023.13	GDH 2/3	354x325	
0312.00012.13	GDH 1/2	325x265	
0312.00013.13	GDH 1/3	325x176	
0312.00014.13	GDH 1/4	265x162	
0312.00016.13	GDH 1/6	176x162	
0312.00024.13	GDH 2/4	530x162	

**Lid for GN Container  
with Long Handle  
Deckel für GN mit  
Langen Griffen**



Code		Dimensions (mm)	Price (€)
0312.00011.14	GDLH 1/1	530x325	
0312.00012.14	GDLH 1/2	325x265	
0312.00013.14	GDLH 1/3	325x176	



**Bainmarie**  
Bainmarie

Code		Dimensions (mm)	h (mm)	Price (€)
0752.11170.01	1/1 bainmarie	510x360	170	
0752.11210.01		510x360	210	
0752.21170.01	2/1 bainmarie	510x630	170	
0752.21210.01		510x630	210	
0752.41170.01	4/1 bainmarie	520x1300	170	
0752.41220.01		520x1300	210	



**GN Trays**  
GN-Konvektomatenbleche

Code		h (mm)	Price (€)
0213.21010.01	OZT 2/1	10	
0213.21020.01	OZT 2/1	20	
0213.21040.01	OZT 2/1	40	
0213.21065.01	OZT 2/1	65	
0213.11010.01	OZT 1/1	10	
0213.11020.01	OZT 1/1	20	
0213.11040.01	OZT 1/1	40	
0213.11065.01	OZT 1/1	65	
0213.23010.01	OZT 2/3	10	
0213.23020.01	OZT 2/3	20	
0213.23040.01	OZT 2/3	40	
0213.23065.01	OZT 2/3	65	
0213.12010.01	OZT 1/2	10	
0213.12020.01	OZT 1/2	20	
0213.12040.01	OZT 1/2	40	
0213.12065.01	OZT 1/2	65	

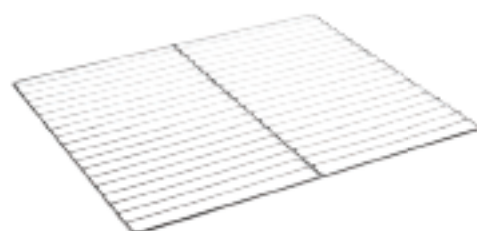

**GN Wire Grid**  
GN Gitter

Code		Dimensions (mm)	Price (€)
0313.00021.20	GN 2/1	650x530	
0313.00011.13	GN 1/1	530x325	

**Stainless Steel / Edelstahl**

Code		Dimensions (mm)	Price (€)
0313.F0021.20	GN 2/1	650x530	
0313.F0011.13	GN 1/1	530x325	

**Chrom Nickel Coated Steel / Stahl mit Chrom Nickel Beschichtet**



**Ice Cream Container**  
Eisbehälter

Code		Dimensions (mm)	h (mm)	Price (€)
0335.36165.10		360x165	100	
0335.36165.12		360x165	120	
0335.36165.15		360x165	150	
0335.36165.17		360x165	170	



**Cutlery Container**  
Besteckkästen

Code	Dimensions (mm)	Capacity (l)	Price (€)
7490.00003.00	550x322x200	3xGN 1/4-100	
7490.00004.00	720x322x200	4xGN 1/4-100	
7490.00005.00	890x322x200	5xGN 1/4-100	

without GN Container/Ohne GN Behälter



**GN Cutlery Box with Hanger**  
GN Besteckkasten mit Anhängervorrichtung

Code	Dimensions (mm)	Capacity (l)	Price (€)
0336.13150.01	325x176x150	5.5	



**GN Cutlery Box**  
Besteckbehälter

Code	Dimensions (mm)	h (mm)	Price (€)
0336.24137.01	265x162	155	



**Insert Base for GN Containers**  
GN-Einlegeplatte, gelocht

Code	Dimensions (mm)	Price (€)
0334.00011.01	OZS 1/1 450x250	
0334.00012.01	OZS 1/2 245x196	
0334.00013.01	OZS 1/3 245x122	



**GN Bars**  
GN-Zwischensteg

Code	Dimensions (mm)	Price (€)
0380.00325.01	OZC 325 325	
0380.00530.01	OZC 530 530	

# International weight and measures

Lenght			Weight			Area		
meters	m/ft	feet	grams	g/oz	ounces	cm <sup>2</sup>	cm <sup>2</sup> /In <sup>2</sup>	In <sup>2</sup>
0,30	1	3,28	28,35	1	0,04	0,30	1	3,28
0,61	2	6,56	56,70	2	0,07	0,61	2	6,56
1,22	4	13,12	113,4	4	0,14	32,26	5	0,78
1,83	6	19,68	141,8	5	0,18	64,52	10	1,66
2,44	8	26,25	283,5	10	0,35	129,03	20	3,10
3,05	10	32,81	567,0	20	0,71	322,58	50	7,75
6,10	20	65,62	850,5	30	1,06	645,16	100	15,50
9,14	30	98,42	1417,5	50	1,76			
15,24	50	164,00	2835,0	100	3,53			

centimeters	cm/in	inches	kilograms	kb/lb	pounds	m <sup>3</sup>	m <sup>2</sup> /ft <sup>3</sup>	ft <sup>3</sup>
2,54	1	0,40	0,45	1	2,21	0,03	1	32,32
5,08	2	0,80	0,91	2	4,41	0,06	2	70,63
7,62	3	1,20	1,81	4	8,82	0,08	3	105,9
10,16	4	1,60	2,27	5	11,02	0,11	4	141,3
12,70	5	2,00	4,54	10	22,05	0,14	5	176,6
15,24	6	2,40	9,07	20	44,09	0,28	10	353,2
17,78	7	2,80	22,68	50	110,20			
20,32	8	3,20	45,36	100	220,50			
22,88	9	3,50						
25,40	10	3,90						
50,80	20	7,90						
127,00	50	19,70						
254,00	100	39,40						

Capacity			Metric Measures and aqulvalents		
liters	liter/US gal	US gals	lenght		
3,79	1	0,26	1 millimeter (mm) =0,0394 pollici		
7,57	2	0,53	1 centimeter (cm) = 10mm =0,3937 pollici		
11,35	3	0,79	1 meter (m) = 1000mm =1,0936 yards		
15,14	4	1,06	1 kilometer (km) = 1000m =0,6214 mile		
18,93	5	1,32	<b>Area</b>		
22,71	6	1,58	1 cm <sup>2</sup> =100mm <sup>2</sup> =0,1550 sq/in		
26,50	7	1,85	1 m <sup>2</sup> =10000cm <sup>2</sup> =1,1960 sq/yds		
30,28	8	2,11	<b>Capacity</b>		
34,16	9	2,38	1 cm <sup>3</sup> =0,0610 cu/in		
37,94	10	2,64	1dm <sup>3</sup> =1000cm <sup>3</sup> =0,0353 cu/ft		
75,88	20	5,28	1 m <sup>3</sup> =1000dm <sup>3</sup> =1,3079 cu/yds		
189,70	50	13,20	1 liter(l) =1 dm <sup>3</sup> =0,2642 US gal		
379,40	100	26,40	<b>Weight</b>		
			1 gram (g) =1000mg =0,0353 oz		
			1 kilogram (kg) =1000g =2,2046 lb		

Temperature												
Celsius	-40	-34,44	-28,89	-23,33	-17,78	-12,22	-6,67	-1,11	2,7	4,4	10	37,7
C / F	-40	-30	-20	+0	0	10	20	30	37	40	50	100
Fahrenheit	-40	-22	-4	14	32	50	68	86	98,6	104	122	212

°C = 5/9 (F-32)

°F = 9/5 C +32

▲ water freeze

▲ body temperature

▲ water boils



# Chafing Dish

*Chafing Dish*



**TURQUOISE Serie****Chafing Dish**

Code	Dimensions (mm)	Capacity	Price (€)
★ 0450.03032.01	350x640x350	GN 1/1	
★★ 0450.03038.01	350x640x350	GN 1/1	

**New Eco-line**

Code	Dimensions (mm)	Capacity	Price (€)
★ 0450.2303P.01	350x640x350	GN 1/1	
★★ 0450.2303R.01	350x640x350	GN 1/1	



Monoblock Lid and S-Shaped Leg is Patented.

**Rolltop Chafing Dish mit Rolltopdeckel**

Code	Dimensions (mm)	Capacity	Price (€)
★ 045L.03032.07	350x640x420	GN 1/1	
★★ 045L.03038.07	350x640x420	GN 1/1	

**New Eco-line**

Code	Dimensions (mm)	Capacity	Price (€)
★ 045L.2303P.01	350x640x420	GN 1/1	
★★ 045L.2303R.01	350x640x420	GN 1/1	

**2/3 Chafing Dish, with Rolltop Lid mit Rolltopdeckel**

Code	Dimensions (mm)	Capacity	Price (€)
★ 0456.13137.07	350x480x400	GN 2/3	
★★ 0456.13138.07	350x480x400	GN 2/3	

**New Eco-line**

Code	Dimensions (mm)	Capacity	Price (€)
★ 0456.2413P.07	350x480x400	GN 2/3	
★★ 0456.2413R.07	350x480x400	GN 2/3	

**Soup Chafing Dish Suspensionstation**

Code	Dimensions (mm)	Capacity	Price (€)
★ 045A.03032.09	350x640x370	2 Soup Pot With	
★★ 045A.03038.09	350x640x370	2 Soup Pot With	

**New Eco-line**

Code	Dimensions (mm)	Capacity	Price (€)
★★ 045A.2303P.09	350x640x370	2 Soup Pot With	
★★ 045A.2303R.09	350x640x370	2 Soup Pot With	

★ with fuel holders / mit Brennstoffhalter  
 ★★ Suitable for electrical heating / Geeignet für Elektrische Heizplatte

## SAPPHIRE Serie



**Chafing Dish**

Code	Dimensions (mm)	Capacity	Price (€)
* 0450.01082.06	350x620x370	GN 1/1	

Code	Dimensions (mm)	Capacity	Price (€)
** 0450.01088.06	350x620x370	GN 1/1	



**Rolltop Chafing Dish mit Rolltopdeckel**

Code	Dimensions (mm)	Capacity	Price (€)
* 045L.01082.07	350x620x420	GN 1/1	

Code	Dimensions (mm)	Capacity	Price (€)
** 045L.01088.07	350x620x420	GN 1/1	



**2/3 Chafing Dish, with Rolltop Lid mit Rolltopdeckel**

Code	Dimensions (mm)	Capacity	Price (€)
* 0456.11087.07	350x460x420	GN 2/3	

Code	Dimensions (mm)	Capacity	Price (€)
** 0456.11088.07	350x460x420	GN 2/3	



**Soup Chafing Dish Suppenstation**

Code	Dimensions (mm)	Capacity	Price (€)
* 045A.01082.09	350x620x370	2 Soup Pot With	

Code	Dimensions (mm)	Capacity	Price (€)
** 045A.01088.09	350x620x370	2 Soup Pot With	

\* with fuel holders / mit Brennstoffhalter  
 \*\* Suitable for electrical heating / Geeignet für Elektrische Heizplatte



**RUBY Serie****Chafing Dish**

Code	Dimensions (mm)	Capacity	Price (€)
★ 0450.04012.04	350x640x390	GN 1/1	188,01

Code	Dimensions (mm)	Capacity	Price (€)
★★ 0450.04018.04	350x640x390	GN 1/1	

**2/3 Chafing Dish**

Code	Dimensions (mm)	Capacity	Price (€)
★ 0452.14017.12	350x480x390	GN 2/3	

Code	Dimensions (mm)	Capacity	Price (€)
★★ 0452.14018.12	350x480x390	GN 2/3	

**Rolltop Chafing Dish mit Rolltopdeckel**

Code	Dimensions (mm)	Capacity	Price (€)
★ 045L.04012.07	350x640x420	GN 1/1	

Code	Dimensions (mm)	Capacity	Price (€)
★★ 045L.04018.07	350x640x420	GN 1/1	

**2/3 Chafing Dish, with Rolltop Lid mit Rolltopdeckel**

Code	Dimensions (mm)	Capacity	Price (€)
★ 0456.14017.07	350x480x440	GN 2/3	

Code	Dimensions (mm)	Capacity	Price (€)
★★ 0456.14018.07	350x480x440	GN 2/3	

**Soup Chafing Dish Suppenstation**

Code	Dimensions (mm)	Capacity	Price (€)
★ 045A.04012.09	350x640x390	2 Soup Pot With	

Code	Dimensions (mm)	Capacity	Price (€)
★★ 045A.04018.09	350x640x390	2 Soup Pot With	

★ with fuel holders / mit Brennstoffhalter  
 ★★ Suitable for electrical heating / Geeignet für elektrische Heizplatte

## OPAL Serie



**Chafing Dish**

Code	Dimensions (mm)	Capacity	Price (€)
★ 0450.20082.06	350x620x370	GN 1/1	

Code	Dimensions (mm)	Capacity	Price (€)
★★ 0450.20088.06	350x620x370	GN 1/1	



**Rolltop Chafing Dish mit Rolltopdeckel**

Code	Dimensions (mm)	Capacity	Price (€)
★ 045L.20082.07	350x620x420	GN 1/1	

Code	Dimensions (mm)	Capacity	Price (€)
★★ 045L.20088.07	350x620x420	GN 1/1	



**2/3 Chafing Dish, with Rolltop Lid mit Rolltopdeckel**

Code	Dimensions (mm)	Capacity	Price (€)
★ 0456.20087.07	350x460x420	GN 2/3	

Code	Dimensions (mm)	Capacity	Price (€)
★★ 0456.20088.07	350x460x420	GN 2/3	



**Soup Chafing Dish Suppenstation**

Code	Dimensions (mm)	Capacity	Price (€)
★ 045A.20082.09	350x620x370	2 Soup Pot WRh	

Code	Dimensions (mm)	Capacity	Price (€)
★★ 045A.20088.09	350x620x370	2 Soup Pot WRh	

★ with fuel holders / mit Brennstoffhalter  
 ★★ Suitable for electrical heating / Geeignet für Elektrische Heizplatte

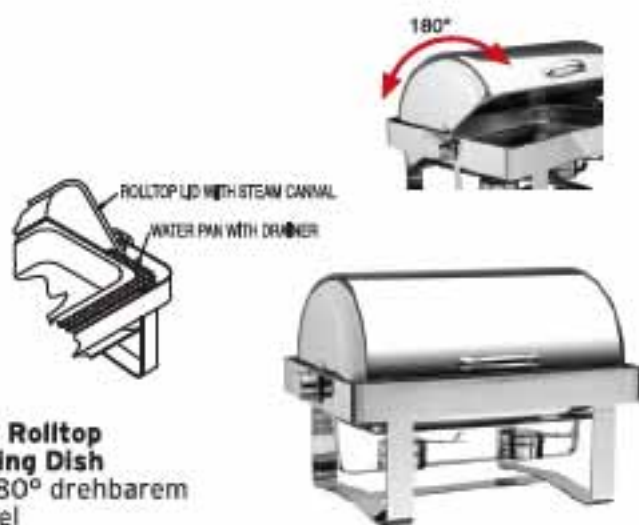

**180° Rolltop Chafing Dish**  
mit 180° drehbarem Deckel

Code	Dimensions (mm)	Capacity	Price (€)
* 045F.05269.16	410x640x420	GN 1/1	

Code	Dimensions (mm)	Capacity	Price (€)
** 045F.05268.16	410x640x420	GN 1/1	



**Built-in 180° Rolltop Chafing Dish**  
Für Thekeneinbau

Code	Dimensions (mm)	Capacity	Price (€)
** 045F.00268.16	410x640x420	GN 1/1	



**Round Chafing Dish with Rolltop Lid**  
mit Rolltopdeckel

Code	Ø (cm)	Capacity	Price (€)
* 045K.0526J.07	40	Ø 36x6 Inset	

Code	Ø (cm)	Capacity	Price (€)
** 045K.0526D.07	40	Ø 36x6 Inset	



**Built-in Round Chafing Dish with Rolltop Lid**  
mit Rolltopdeckel,  
für Thekeneinbau

Code	Ø (cm)	Capacity	Price (€)
** 045K.0026D.07	40	Ø 36x6 Inset	



**Soup Chafing Dish**  
Suppenstation  
mit Rolltopdeckel



Code	Ø (cm)	Capacity (l)	Price (€)
★★ 045N.0526H.07	40	9	

**Round Chafing Dish**  
Rund Chafing Dish



Code	Ø (cm)	Capacity (l)	Price (€)
★ 045M.0307G.06	60	20	
★ 045M.0307I.06	80	36	



**Folding Chafing Dish,  
Klappbar**



Code	Dimensions (mm)	Capacity	Price (€)
★ 045D.08255.15		GN 1/1	

Code	Dimensions (mm)	Capacity	Price (€)
★★ 045D.08258.15		GN 1/1	

★ with fuel holders / mit Brennstoffhalter  
★★ Suitable for electrical heating / Geeignet für Elektrische Heizplatte



**Stackable Chafing Dish**  
Ineinander Stapelbar

Code	Dimensions (mm)	Capacity	Price (€)
★ 045D.09262.14		GN 1/1	
★★ 045D.09268.14		GN 1/1	

**New Eco-line**

Code	Dimensions (mm)	Capacity	Price (€)
★ 045D.2926P.07		GN 1/1	
★★ 045D.2926R.07		GN 1/1	



**Stackable Rolltop Chafing Dish**  
Ineinander Stapelbar, mit Rolltopdeckel

Code	Dimensions (mm)	Capacity	Price (€)
★ 045L.09262.07	350x590x420	GN 1/1	
★★ 045L.09268.07	350x590x420	GN 1/1	

**New Eco-line**

Code	Dimensions (mm)	Capacity	Price (€)
★ 045L.2926P.07	350x590x420	GN 1/1	
★★ 045L.2926R.07	350x590x420	GN 1/1	

Patent No: 2001 00752  
Official Industrial Design No: 40208085.8



**AMBER**  
Chafing Dish

Code	Dimensions (mm)	Capacity	Price (€)
★ 0450.21261.06	350x640x350	GN 1/1	

Code	Dimensions (mm)	Capacity	Price (€)
★★ 0450.21268.06	350x640x350	GN 1/1	



**AMBER**  
Rolltop Chafing Dish  
mit Rolltopdeckel

Code	Dimensions (mm)	Capacity	Price (€)
★ 045L.21261.07	350x640x420	GN 1/1	

Code	Dimensions (mm)	Capacity	Price (€)
★★ 045L.21268.07	350x640x420	GN 1/1	

★ with fuel burners / mit Brennstoffbrenner  
★★ Suitable for electrical heating / Geeignet für Elektrische Heizplatte

**Bainmarie**

Code	Dimensions (mm)	Capacity	Price (€)
7854.GN11D.01	530x340x240	GN 1/1	

**Bainmarie, with Rolltop mit Rolltop**

Code	Dimensions (mm)	Capacity	Price (€)
7854.GN11R.01	530x340x360	GN 1/1	

**Bainmarie**

Code	Dimensions (mm)	Capacity	Price (€)
7854.GN11N.01	530x340x245	GN 1/1	



Code	Dimensions (mm)	Capacity	Price (€)
7854.GN231.01	340x350x350	1 Soup Pot	

with 1kW elec. heater, 30-90 °C temp.

**Soup Bainmarie Suppenstation**

Code	Dimensions (mm)	Capacity	Price (€)
7854.GN112.01	530x320x300	2 Soup Pot	

with 1kW elec. heater, 30-90 °C temp.



**Electric Soup Kettle**  
Suppenterrine,  
Elektrisch

Code	Dimensions (mm)	Capacity	Price (€)
8479.00000.00	410x305x305		
with 0.66 kW elec. heater, 30-90°C temp.			



**Electrical Heater for Chafing Dish**  
Elektrische Heizplatte

Code		Price (€)
8917.00002.03	without regulator	350 W
0917.00002.05	with regulator	600 W



**Gel for Chafing Dish, Plastic bucket**  
Brennpaste, Plastik Eimer

Code		Capacity	Price (€)
8199.04000.01	Methanol	4 kg	
8199.04000.02	Ethanol	4 kg	



**Gel for Chafing Dish Brennpaste**

Code		Capacity	Price (€)
8199.00225.01	Methanol	200 gr	
8199.00225.02	Ethanol	200 gr	
72 pcs in one box			



# T r o l l e y s

*Transportwagen*







**Rack Stacking Trolley, s/s**  
Stapelwagen für  
Spülmaschinen körbe

Code	Dimensions (mm)	Capacity (Basket)	Price (€)
7959.55659.01	550x650x900	10	



**Tray Stacking Trolley, s/s**  
Stapelwagen für  
Tabletten

Code	Dimensions (mm)	Capacity (Tray)	Price (€)
7959.55302.02	550x650x900/1300	50	



**Basket Trolley, s/s**  
Transportwagen für  
Spülmaschinenkörbe

Code	Dimensions (mm)	Capacity (Basket)	Price (€)
7959.60578.40	600x600x850	10	



**Tray Carrying  
Trolley, s/s**  
Transportwagen für  
Tabletten



Code	Dimensions (mm)	Capacity (Tray)	Price (€)
7959.85587.80	850x580x780	75	

**Plate Trolley, s/s**  
Transportwagen für  
Teller



Code	Dimensions (mm)	Capacity (plate)	Price (€)
7959.10052.80	980x500x780	150	

**Dirty Dish  
Collecting Trolley, s/s**  
Sammelwagen für  
Teller



Code	Dimensions (mm)	Price (€)
7959.87579.50	800x550x850	



**Service Trolley  
2 Shelves, s/s**  
Servierwagen, 2 Borde

Code	Dimensions (mm)	Price (€)
0913.00507.01	550x800x850	



**Service Trolley  
3 Shelves, s/s**  
Servierwagen, 3 Borde

Code	Dimensions (mm)	Price (€)
0913.00508.01	550x800x850	



**Ingredient Bin**  
Zutaten Behälter

Code	Dimensions (mm)	Price (€)
9370.03602.00	749 x 394 x 711	



**Waste Bin with Pedal, s/s**  
Treteimer, Edelstahl



Code	Ø (cm)	h (cm)	Capacity (l)	Price (€)
8893.00403.00	18	22.5	3	
8893.00404.00	18	26	4	
8893.00405.00	18	29.5	5	
8893.00413.00	27	35.5	13	
8893.00416.00	27	40	16	

**Heavy Duty Waste Bin with Pedal, s/s**  
Großküchen Treteimer, Edelstahl

\*New PATENTED advanced hydraulic lid mechanism provides more controlled and gradually closing.



Code	Ø (cm)	h (cm)	Capacity (l)	Price (€)
8893.04050.00	40	50	50	
8893.04070.00	40	70	70	
8893.04090.00	40	90	90	

**Heavy Duty Waste Bin, s/s**  
Abfalleimer, Edelstahl



Code	Ø (cm)	h (cm)	Capacity (l)	Price (€)
0893.04040.01	40	40	47.5	

**Dust Bin**  
Abfalleimer



Code	Color	Capacity (l)	Price (€)
8893.00120.00	Green	120	
8893.00240.00	Green	240	
8893.00770.00	Green	770	



# Kitchen Utensils

*Küchenzubehör*





Heavy Duty Ladle, s/s  
Schöpflöffel

Code	Ø (cm)	Length of handle (cm)	Capacity (l)	Price (€)
8468.00007.01	18	70	0,98	
8468.00008.01	20	80	1,40	
8468.00009.01	23	90	2,15	
8468.00010.01	25,5	100	3,05	

Heavy Duty Supported Ladle



One Piece Heavy Duty  
Ladle, s/s  
Schöpflöffel, fugenlos

Code	Ø (cm)	Length of handle (cm)	Capacity (l)	Price (€)
9468.00065.00	6,5	27	0,07	
9468.00008.00	8	32	0,13	
9468.00009.00	9	34	0,20	
9468.00010.00	10	38	0,25	
9468.00012.00	12	40	0,50	
9468.00014.00	14	44	0,75	
9468.00016.00	16	50	1	



One Piece Heavy  
Duty Skimmer, s/s  
Schaumlöffel, fugenlos

Code	Ø (cm)	Length of handle (cm)	Capacity (l)	Price (€)
9340.00008.00	8	32		
9340.00010.00	10	38		
9340.00012.00	12	40		
9340.00014.00	14	44		
9340.00016.00	16	50		



**One Piece Serving  
Spoon, s/s  
Servierlöffel, fugenlos**



Code	Ø (cm)	Length of handle (cm)	Capacity (l)	Price (€)
9481.26000.50		27		
9481.26000.10		38		
9481.26000.30		43		

**One Piece Perforated  
Spoon, s/s  
Servierlöffel, fugenlos,  
Perforiert**



Code	Ø (cm)	Length of handle (cm)	Capacity (l)	Price (€)
9481.26000.60		27		
9481.26000.20		38		
9481.26000.40		43		

**One Piece Sauce Spoon/  
Left Handed, s/s  
Saucelöffel, fugenlos,  
für Linkshändler**



Code	Ø (cm)	Length of handle (cm)	Capacity (l)	Price (€)
8481.27000.50		27		
8481.27000.10		38		
8481.27000.30		43		

**One Piece Perforated Sauce Spoon/  
Left Handed, s/s  
Saucelöffel, fugenlos,  
für Linkshändler, perforiert**



Code	Ø (cm)	Length of handle (cm)	Capacity (l)	Price (€)
8481.27000.60		27		
8481.27000.20		38		
8481.27000.40		43		





Meat Fork,  
2 Prongs, s/s  
Fleischgabel, 2 Zacken



Code	Ø (cm)	Length of handle (cm)	Capacity (l)	Price (€)
8481.02004.01		30		

One Piece Meat Fork,  
2 Prongs, s/s  
Fleischgabel  
2 Zacken, fugenlos



Code	Ø (cm)	Length of handle (cm)	Capacity (l)	Price (€)
8481.26000.70		50		
8481.26000.80		70		

One Piece Meat Fork,  
3 Prongs, s/s  
Fleischgabel  
3 Zacken, fugenlos



Code	Ø (cm)	Length of handle (cm)	Capacity (l)	Price (€)
8481.26000.90		50		
8481.26001.00		70		

Serving Spatula, s/s  
Backschaufel



Code	Dimensions (cm)	Length of handle (cm)	Capacity (l)	Price (€)
8481.02005.04	11x8	30		

Solid

Code	Dimensions (cm)	Length of handle (cm)	Capacity (l)	Price (€)
8481.02005.03	11x8	30		

Perforated



One Piece Serving  
Spatula, s/s  
Backschaufel, fugenlos



Code	Dimensions (cm)	Length of handle (cm)	Capacity (l)	Price (€)
8481.27001.10	11x8	27		
8481.27000.70	11x8	36		
8481.27000.90	11x8	39		

One Piece Perforated  
Serving Spatula, s/s  
Backschaufel, fugenlos,  
perforiert



Code	Dimensions (cm)	Length of handle (cm)	Capacity (l)	Price (€)
8481.27001.20	11x8	27		
8481.27000.80	11x8	36		
8481.27001.00	11x8	39		

Tinned Mesh Skimmer,  
Thick Wired  
Drahtlöffel, verzinkt



Code	Ø (cm)	Length of handle (cm)	Capacity (l)	Price (€)
8340.00014.03	14			
8340.00017.03	17			
8340.00019.03	19			
8340.00022.03	22			
8340.00024.03	24			
8340.00027.03	27			
8340.00030.03	30			

Tinned Mesh Skimmer,  
Thin Wired  
Schaumlöffel, verzinkt



Code	Ø (cm)	Length of handle (cm)	Capacity (l)	Price (€)
8340.00014.04	14			
8340.00017.04	17			
8340.00019.04	19			
8340.00022.04	22			
8340.00024.04	24			
8340.00027.04	27			
8340.00030.04	30			

Tinned Strainer  
Passiersieb, verzinkt



Code	Ø (cm)	Length of handle (cm)	Capacity (l)	Price (€)
8337.00012.01	12			
8337.00014.01	14			
8337.00017.01	17			



Code	Ø (cm)	Length of handle (cm)	Capacity (l)	Price (€)
8337.00022.01	22			
8337.00025.01	25			

Supported



Chinese Colander , s/s  
Spitzsieb, Edelstahl

Code	Ø (cm)	Length of handle (cm)	Capacity (l)	Price (€)
9337.34101.40	14			
9337.77172.00	16			
9337.77174.00	20			
9337.77176.00	25			



Whisk , s/s  
Rührbesen, Edelstahl

Code	Ø (cm)	Total Length (cm)	Capacity (l)	Price (€)
9338.00030.00		30		
9338.00035.00		35		
9338.00040.00		40		
9338.00045.00		45		
9338.00050.00		50		



Whisk with, s/s handle  
Rührbesen mit Edelstahl Griff

Code	Ø (cm)	Length of handle (cm)	Capacity (l)	Price (€)
8338.00001.03		45		
8338.00002.03		50		
8338.00003.03		60		
8338.00004.03		65		
8338.00005.03		70		
8338.00006.03		95		
8338.00007.03		100		



Serving Spoon, PC  
Servierlöffel,  
Polycarbonat



Code	Ø (cm)	Length of handle (cm)	Capacity (l)	Price (€)
8481.PDF32.10		29		
Solid				
Code	Ø (cm)	Length of handle (cm)	Capacity (l)	Price (€)
8481.PDF32.20		29		
Perforated				

Sauce Ladle, PC  
Dressinglöffel,  
Polycarbonat



Code	Ø (cm)	Length of handle (cm)	Capacity (l)	Price (€)
8468.PDF35.00		25		

Serving Ladle-2 Side  
Pourer PC  
Servierlöffel,  
Polycarbonat



Code	Ø (cm)	Length of handle (cm)	Capacity (l)	Price (€)
8468.PDF34.00		27		

Serving Tong, PC  
Servierzange,  
Polycarbonat



Code	Ø (cm)	Total Length (cm)	Capacity (l)	Price (€)
8467.PDF30.69		23		
8467.PDF30.72		30		

Ice Tong, PC  
Eiszange,  
Polycarbonat



Code	Ø (cm)	Total Length (cm)	Capacity (l)	Price (€)
8467.PDF30.77		18		

Spaghetti Tong, s/s  
Spaghettizzange

Code	Ø (cm)	Total Length (cm)	Capacity (l)	Price (€)
9467.0000L06		21.5		

Code	Ø (cm)	Total Length (cm)	Capacity (l)	Price (€)
8467.01005.00		23		



Code	Ø (cm)	Total Length (cm)	Capacity (l)	Price (€)
9467.0000L04		21		



Code	Ø (cm)	Total Length (cm)	Capacity (l)	Price (€)
8467.01002.00		23		



Code	Ø (cm)	Total Length (cm)	Capacity (l)	Price (€)
8467.02005.00		26.5		

Serving Tong, s/s  
Servierzange

Code	Ø (cm)	Total Length (cm)	Capacity (l)	Price (€)
8467.02004.00		29		

Pastry Tong, s/s  
Kuchenzange

Code	Ø (cm)	Total Length (cm)	Capacity (l)	Price (€)
9467.00002.03		21		



Fish Tong, s/s  
Fischzange



Code	Ø (cm)	Total Length (cm)	Capacity (l)	Price (€)
8467.00448.05		23		

Ice Tong, s/s  
Eiswürfelzange



Code	Ø (cm)	Length (cm)	Capacity (l)	Price (€)
9467.00005.07		16		

Sugar Tong, s/s  
Zuckerzange



Code	Ø (cm)	Length (cm)	Capacity (l)	Price (€)
9467.01332.01		13		

Grill Tong, s/s  
Grillzange



Code	Ø (cm)	Length (cm)	Capacity (l)	Price (€)
8467.00001.01		24.5		
8467.00001.02		26.5		
8467.00001.03		32.5		

Bread Knife, s/s  
Brotmesser

Code	h (cm)	Price (€)
8350.00003.01	23	

Paring Knife, s/s  
Küchenmesser

Code	h (cm)	Price (€)
8350.00006.01	11.5	
8350.00006.02	16	

Vegetables Knife, s/s  
Gemüsemesser

Code	h (cm)	Price (€)
8350.00006.06	10	

Carving Knife, s/s  
Schlachtsmesser

Code	h (cm)	Price (€)
8350.00006.03	19	

Chef's Knife, s/s  
Kochmesser

Code	h (cm)	Price (€)
8350.03009.00	11	
8350.03010.00	14	
8350.03011.00	15.5	
8350.03012.00	17.5	
8350.03013.00	19.5	
8350.03014.00	23	

Boning Knife, s/s  
Ausbeinmesser

Code	h (cm)	Price (€)
8350.03020.00	18	
8350.03021.00	20	
8350.03022.00	22	

Ham Slicer, s/s  
Schinkenmesser

Code	h (cm)	Price (€)
8350.00011.00	15.5	



Code	h (cm)	Price (€)
8350.00011.01	11	



Code	h (cm)	Price (€)
8350.00000.04	25	



Decoration Set 4 pcs, s/s  
Dekoriermesser Set



Code	h (cm)	Price (€)
8350.00012.08		

Meat Cleaver, s/s  
Hackbeil



Code	h (cm)	Weight (gr)	Price (€)
8350.00014.20	19.5	660	
8350.00014.30	21.5	740	

Long Handle			
Code	h (cm)	Weight (gr)	Price (€)
8350.00014.04	18.5	900	

Doner Knife, s/s  
Dönermesser



Code	h (cm)	Price (€)
8350.40450.01	45	
8350.40500.01	50	
8350.40550.01	55	

Pastry Spatula, s/s  
Tortenspachtel



Code	h (cm)	Price (€)
8620.00003.01	25	
8620.00003.02	30	
8620.00003.03	35	

Pizza Spatula, s/s  
Pizzaspachtel



Code	Dimensions (cm)	Price (€)
8620.00003.04		
8620.00003.05		

Spatula, s/s  
Spachtel



Code	Dimensions (cm)	Price (€)
8620.00000.10	7.5x8.5	
8620.00000.20	8.5x9.5	
8620.00000.30	10x10.5	
8620.00000.40	11.5x10.5	





### Polyethylene Cutting Board

Color Code cutting boards are the ultimate defense in the prevention of cross-contamination. They are exceptionally durable and essential for safe food preparation. Polyethylene cutting boards are dishwasher safe.

### Polyethylene Schneidbretter

Color Code Schneidbretter haben den ultimativen Schutz und die Verhütung gegen Verschmutzungen. Sie sind überaus haltbar und unentbehrlich für die Vorbereitung von gesunden Speisen. Die Polyethylen-Schneidbretter sind spülmaschinentauglich.



Dairy

Poultry

Fish

Meat

Cooked Food

Fruits &amp; Vegetables

Code Plain ohne Saltz	Color Farbe	LxWxH (cm.)	Price (€)
8356.32526.00	white/weiß	32.5x26.5x2	
8356.32526.10	red/rot	32.5x26.5x2	
8356.32526.20	blue/blau	32.5x26.5x2	
8356.32526.30	yellow/gelb	32.5x26.5x2	
8356.32526.40	green/grün	32.5x26.5x2	
8356.32526.50	brown/braun	32.5x26.5x2	
8356.53325.00	white/weiß	53x32.5x2	
8356.53325.10	red/rot	53x32.5x2	
8356.53325.20	blue/blau	53x32.5x2	
8356.53325.30	yellow/gelb	53x32.5x2	
8356.53325.40	green/grün	53x32.5x2	
8356.53325.50	brown/braun	53x32.5x2	
8356.50302.00	white/weiß	50x30x2	
8356.50302.10	red/rot	50x30x2	
8356.50302.20	blue/blau	50x30x2	
8356.50302.30	yellow/gelb	50x30x2	
8356.50302.40	green/grün	50x30x2	
8356.50302.50	brown/braun	50x30x2	
8356.60402.00	white/weiß	60x40x2	
8356.60402.10	red/rot	60x40x2	
8356.60402.20	blue/blau	60x40x2	
8356.60402.30	yellow/gelb	60x40x2	
8356.60402.40	green/grün	60x40x2	
8356.60402.50	brown/braun	60x40x2	
8356.60404.00	white/weiß	60x40x4	
8356.60404.10	red/rot	60x40x4	
8356.60404.20	blue/blau	60x40x4	
8356.60404.30	yellow/gelb	60x40x4	
8356.60404.40	green/grün	60x40x4	
8356.60404.50	brown/braun	60x40x4	

Cutting Boards  
Schneidbretter



Code Grooved mit Safrin(e)	Color Farbe	LxWxH (cm.)	Price (€)
8356.32526.01	white/weiß	32,5x26,5x2	
8356.32526.11	red/rot	32,5x26,5x2	
8356.32526.21	blue/blau	32,5x26,5x2	
8356.32526.31	yellow/gelb	32,5x26,5x2	
8356.32526.41	green/grün	32,5x26,5x2	
8356.32526.51	brown/braun	32,5x26,5x2	
<hr/>			
8356.53325.01	white/weiß	53x32,5x2	
8356.53325.11	red/rot	53x32,5x2	
8356.53325.21	blue/blau	53x32,5x2	
8356.53325.31	yellow/gelb	53x32,5x2	
8356.53325.41	green/grün	53x32,5x2	
8356.53325.51	brown/braun	53x32,5x2	
<hr/>			
8356.50302.01	white/weiß	50x30x2	
8356.50302.11	red/rot	50x30x2	
8356.50302.21	blue/blau	50x30x2	
8356.50302.31	yellow/gelb	50x30x2	
8356.50302.41	green/grün	50x30x2	
8356.50302.51	brown/braun	50x30x2	
<hr/>			
8356.60402.01	white/weiß	60x40x2	
8356.60402.11	red/rot	60x40x2	
8356.60402.21	blue/blau	60x40x2	
8356.60402.31	yellow/gelb	60x40x2	
8356.60402.41	green/grün	60x40x2	
8356.60402.51	brown/braun	60x40x2	



Cutting Boards  
Storage Rack  
Schneidbretthalter



Code		LxWxH (cm.)	Price (€)
0356.31144.01	6 division	29x28,5x33	21,36

Tumbler, s/s  
Edelstahlbecher

Code	Ø (cm)	h (cm)	Capacity (l)	Price (€)
0466.00807.01	8	7		
0466.00808.01	8	8		
0466.00809.01	8	9		

Jug, s/s  
Kanne

Code	Ø (cm)	h (cm)	Capacity (l)	Price (€)
0469.01216.01	with lid	12	16	1,75
0469.01118.01	without lid	11	18	1,75

Pot for  
Milk or Coffee, s/s  
Kanne für Milch oder Kaffee

Code	Capacity (l)	Price (€)
8534.00003.02	0.30	
8534.00005.02	0.50	
8534.00007.02	0.70	
8534.00010.02	1.00	
8534.00015.02	1.50	
8534.00020.02	2.00	
<b>With Lid / Mit Deckel</b>		
8534.00003.00	0.30	
8534.00005.00	0.50	
8534.00007.00	0.70	
8534.00010.00	1.00	
8534.00015.00	1.50	
8534.00020.00	2.00	

Vacuum Jug, s/s  
Termokanne

Code	Capacity (l)	Price (€)
9497.00000.02	1,5	

Turkish Coffee  
Maker, s/s  
Maschine Für  
Türkischen Kaffee

Code	Capacity (l)	Price (€)
8574.00CP1.00	0.40	



Utility Scoop, s/s  
Schaufel



Code	Capacity (l)	Price (€)
8479.00002.02	0.10	
8479.00003.03	0.20	
8479.00004.04	0.50	
8479.00005.05	1.00	
8479.00006.06	2.00	

Sauce Boat, s/s  
Sauciere auf Fuß



Code		Capacity (cc)	Price (€)
0326.01307.01	small	160	
0326.01709.01	medium	220	
0326.01809.01	large	320	

Mixing Bowl, s/s  
Rührschüssel



Code	Ø (cm)	h (cm)	Capacity (l)	Price (€)
0331.02514.01	25	14	5	
0331.02817.01	28	17	7	
0331.03220.01	32	20	10.5	
0331.03622.01	36	22	14.5	
0331.04024.01	40	24	22.5	

Can Opener  
Dosenöffner



Code	Price (€)
8883.0000E.00	



**Bread Basket**  
Brotkorb

Code		LxW (mm)	Price (€)
0478.02121.10	solid	21x21	
0478.02121.20	perforated	21x21	



**Plate Cover**  
Tellerdeckel

Code	Ø (cm)	Suitable Plate Ø (cm)	Price (€)
0462.00023.01	23.5	23	
0462.00025.01	25.5	25	
0462.00028.01	28.5	28	



**Round Tray, s/s**  
Buffetplatte, Rund

Code	Ø (cm)	h (cm)	Price (€)
8210.00029.00	29	2	
8210.00032.50	32	2	
8210.00037.50	38	2.2	
8210.00041.00	40	2.4	
8210.00046.00	46	2.6	
8210.00049.50	50	3	
8210.00056.00	55	3	
8210.00060.00	58	3	
8210.00064.50	65	3	
8210.00070.00	70	3	
8210.00074.00	75	3	
8210.00079.00	80	3	
8210.00085.00	86	3	
8210.00092.00	95	3.5	



**Serving Tray**  
Servier Tablett, Laminat

Code	Ø (cm)	LxW (cm)	Price (€)
8448.02435.00		24x35	
8448.03244.00		32x44	
8448.03646.00		36x46	
8448.03753.00		37x53	
8448.04361.00		43x61	

Round/Rund

8448.00R32.00	32		
8448.00R38.00	38		
8448.00R43.00	43		

Non Slip/Rutschfest

Code	Ø (cm)	LxW (mm)	Price (€)
8448.02435.01		24x35	
8448.03244.01		32x44	
8448.03646.01		36x46	
8448.03753.01		37x53	
8448.04361.01		43x61	

Round/Rund

8448.00R32.01	32		
8448.00R38.01	38		
8448.00R43.01	43		

**Serving Tray-Non Slip**  
Servier tablett, Laminat,  
Rutschfest



**Banquet Tray,  
Rectangular  
Bankettplatte,  
Rechteckig**



Code	Dimensions (cm)	Price (€)
0449.06544.01	65x44x2	
0449.07550.01	75x50x2	
0449.08250.01	82x50x2	
0449.10065.01	100x65x2	

**Banquet Tray,  
Round  
Bankettplatte, Rund**



Code	Dimensions (cm)	Price (€)
0449.00032.01	32x2	
0449.00040.01	40x2	
0449.00050.01	50x2	
0449.00060.01	60x2	
0449.00080.01	80x2	

**Banquet Tray, Oval  
Bankettplatte, Oval**



Code	Dimensions (cm)	Price (€)
0449.29225.01	29x22.5x2	
0449.03426.01	34.5x26x2	
0449.40295.01	40x29.5x2	
0449.46335.01	46x33.5x2	
0449.52365.01	52x36.5x2	
0449.05640.01	56x40x2	
0449.62435.01	62x43.5x2	
0449.07048.01	70x48x2	



**Buffet Tray, Oval  
with Rim  
Buffetplatte, Oval**



Code	Dimensions (cm)	Price (€)
0420.03625.11	36x25	
0420.42285.11	42x28.5	
0420.05134.11	51x34	



**Meat Tray, Oval  
with Rim  
Bratenplatte, Oval**



Code	Dimensions (cm)	Price (€)
0420.02619.01	26x19	
0420.31215.01	31x21.5	
0420.03625.01	36x25	
0420.42285.01	42x28.5	
0420.04731.01	47x31	
0420.05134.01	51x34	
0420.05638.01	56.5x38	
0420.06341.01	63.5x41	



Breakfast Tray  
Frühstückstablett



Code	LxW (cm)	Price (€)
0443.29176.01	29x17	

Self Service Tray/  
TH Type  
Selbstbedienungstablett,  
TH Type



Code	LxW (cm)	Price (€)
0440.04028.01	40x28	

Self Service Tray/  
MEB Type  
Selbstbedienungstablett,  
MEB Type



Code	LxW (cm)	Price (€)
0440.04029.01	40x29	

## Bar Equipment Barausstattungen



Saray

Code	Ø (cm)	h (cm)	Capacity (l)	Price (€)
0510.19225.31	19	22.5		

Vine Bucket / Weinkühler

Code	Ø (cm)	h (cm)	Capacity (l)	Price (€)
0520.01415.31	14	15		

Ice Bucket / Eiseimer



Villa

Code	Ø (cm)	h (cm)	Capacity (l)	Price (€)
0510.02121.31	21	21		

Vine Bucket / Weinkühler

Code	Ø (cm)	h (cm)	Capacity (l)	Price (€)
0520.01313.31	13	13		

Ice Bucket / Eiseimer



Konak

Code	Ø (cm)	h (cm)	Capacity (l)	Price (€)
0510.17135.31	17	13.5		
0510.20155.31	20	15.5		
0510.24195.31	24	19.5		

Vine Bucket / Weinkühler

Code	Ø (cm)	h (cm)	Capacity (l)	Price (€)
0520.01310.31	13	10		

Ice Bucket / Eiseimer



Igloo

Code	Ø (cm)	h (cm)	Capacity (l)	Price (€)
0510.18521.11	18.5	21		

Vine Bucket with Stand / Weinkühler mit Stand

Code	Ø (cm)	Height (cm)	Capacity (l)	Price (€)
0510.18521.21	18.5	21		

Vine Bucket without Stand / Weinkühler ohne Stand





## Bar Equipment Barausstattungen



Best with VILLA vine bucket

Vine Bucket Stand  
Ständer für Weinkühler

Code	Ø (cm)	h (cm)	Capacity (l)	Price (€)
0510.01668.31	16	68		



Punch Bowl  
Champagner-Kühler



Code	Ø (cm)	h (cm)	Capacity (l)	Price (€)
0464.00038.01	38			

Thermos Ice Bucket  
With Lid  
Termo-Eisbehälter  
mit Deckel



Code	Ø (cm)	h (cm)	Capacity (l)	Price (€)
8520.00000.06	15	9	0,7	

Round Ashtray  
Ashenbecher, rund



Code	Ø (mm)	Price (€)
0476.00014.01	140	
0476.00012.01	120	
0476.00010.01	100	